

SKU: 104-01406

RONIN TACTICAL SERIES

VM4 T6 PDW OPERATOR'S MANUAL

**KWA**  
**Ronin**  
**TACTICAL**  
**SERIES**



# RONIN T6

VM4 TACTICAL 6 PDW  
OPERATOR'S MANUAL

**KWA**  
KWA-USA.COM

## **TABLE OF CONTENTS**

<b>WARRANTY</b>	<b>..... PAGE 2-3</b>
<b>USE OF MANUAL</b>	<b>..... PAGE 4-5</b>
<b>0 - RIFLE SPECIFICATIONS</b>	<b>..... PAGE 6</b>
<b>1 - THE BASICS</b>	<b>..... PAGE 7</b>
<b>2 - LOADING BB'S</b>	<b>..... PAGE 8</b>
<b>3 - ADJUSTING SIGHTS AND FPS</b>	<b>..... PAGE 9-10</b>
<b>4 - HOP UP ADJUSTMENT</b>	<b>..... PAGE 11</b>
<b>5 - DISASSEMBLING THE GUN</b>	<b>..... PAGE 12</b>
<b>6 - TROUBLESHOOTING</b>	<b>..... PAGE 13</b>
<b>7 - PARTS DIAGRAM PAGE 1</b>	<b>..... PAGE 14</b>
<b>8 - PARTS DIAGRAM PAGE 2</b>	<b>..... PAGE 15</b>



## USE OF THIS MANUAL

Before operating your KWA product, read this manual in its entirety. Important safety topics and tips are discussed throughout all of the chapters. It's important that the operator know the principles of gun handling, safety, and operation prior to attempting to operate an airsoft product.

## SAFETY GUIDELINES

### Safety Distance

The effective shooting range of this product is approximately 175 feet. BBs fired from this airsoft rifle may travel farther than intended. Make certain that you have an adequate backstop.

### Eye Protection

Eye protection should be worn at all times when either using or conducting maintenance and cleaning on your airsoft product.

### Assume Every Gun is Always Loaded

This is the first rule of gun safety, so don't forget it! Treat every gun as if it were loaded, all the time. Never assume that the chamber is empty based on your memory or someone else's word. Always remove the magazine and visually check to confirm that the chamber is empty, and that there is no power present (battery or gas) in the airsoft product before beginning cleaning or maintenance.

### Beware of Barrel Obstructions

Ensure that the airsoft product's barrel is free of obstructions before you fire the gun. Even the smallest obstruction such as dirt, dust, or a stuck cleaning patch can cause a jam, misfire, or malfunction.

### Muzzle Control

Always keep the muzzle of the gun pointed in a safe direction. Never point the muzzle at a person or object that you do not intend to shoot.

### Keep Your Safety On

ALWAYS keep the muzzle of the gun pointed in a safe direction. NEVER point the muzzle at a person or object that you do not intend to shoot.

### Keep Your Finger Off The Trigger

Keep your finger off of the trigger and out of the trigger guard until your sights are aligned on your target and you are ready to fire.

### Identify Your Target and Backstop

Before you pull the trigger, make certain of your target and what is beyond it. The Airsoft gun should never be fired at surfaces such as rocks, glass, water, or other hard surfaces where BBs are likely to ricochet in unpredictable directions.



### WARNING:

- Airsoft BBs can be a choking hazard. Keep them away from children.
- Failure to follow safety guidelines may result in serious injury.

## SAFETY GUIDELINES (CONTINUED)

### Failure To Fire

If the airsoft gun fails to fire, misfires, or malfunctions, do not look into the gun barrel. BBs may be lodged in the chamber, and serious eye injury may occur if the BBs are expelled suddenly. Remove the battery/gas, and safely attempt to dislodge the obstruction.

### Maintain Your Gun Properly

Performing proper maintenance, as outlined in this manual, ensures that your airsoft gun will be safe to shoot and will perform to its designed specifications for many years. Alterations, modifications or adjustments may damage your airsoft gun, make it unsafe to shoot, and will immediately void all warranty claims with KWA.

### Store Your Gun Safely

Always store the airsoft gun in a safe place, and out of reach of children. Keep the safety engaged, and remove the magazine, and any batteries or gas before storing your product over any extended amount of time.

**NOTE: IT IS YOUR RESPONSIBILITY TO TAKE EVERY REASONABLE PRECAUTION TO ENSURE THE SAFE STORAGE AND TRANSPORTATION OF YOUR AIRSOFT GUN.**

### Orange Tip

The orange tip on Airsoft guns help Law Enforcement distinguish the replica guns from their real firearm counterparts. Altering the coloration or markings required by state or Federal law so as to make the product look more like a firearm is dangerous and may be a crime. Operator assumes all risks and responsibility when doing so.

### Hazards of Being Mistaken for a Real Firearm

Airsoft guns have been mistaken by Police and Law Enforcement as real firearms. A confrontation with law enforcement while carrying an airsoft gun can result in serious injury or even death. It is strongly advised to operate this airsoft product at a safe and legal location. In the event that you are approached by Law Enforcement personnel, you must comply with their instructions immediately to avoid an incident. Always transport any airsoft products in a carrying case and never display them in a public place.

### Alcohol, Medications, and Drugs

Do not handle or operate your airsoft gun while under the influence of alcohol, medication or drugs.

### Your Responsibility

Your KWA product is well-engineered and manufactured to the highest standards. It was carefully inspected before it was packaged and shipped from our factory. Its safe use depends on you alone. You are the ultimate safety device. Like many other devices, your airsoft gun is safe unless handled in an irresponsible or uneducated manner.



### WARNING:

- Adult supervision is required for any person under the age of 18.
- Alterations and/or modifications to your KWA airsoft gun will void all warranty claims.



KWA PERFORMANCE INDUSTRIES, INC.  
18571 E. Gale Ave.  
City of Industry, CA 91748  
(626) 581-1777

---

## WARRANTY

THANK YOU FOR PURCHASING A KWA PERFORMANCE INDUSTRIES, INC. PRODUCT. KWA Performance Industries, Inc. is committed to serving our customers with the finest quality products, the highest level of service, and the best customer satisfaction. Because of this, we offer a 90 day warranty on KWA products sold by us and our KWA Authorized Resellers.

### Warranty Coverage

Except as specified below, this warranty covers all defects in material and workmanship in KWA products that occur during the above warranty period. The following are not covered by the warranty: (1) Any product which is not imported and distributed in the U.S.A. by KWA PERFORMANCE INDUSTRIES, INC. (2) Any products not purchased in the U.S.A. from a KWA AUTHORIZED RESELLER. If you are uncertain as to whether a reseller is a KWA AUTHORIZED RESELLER, please contact KWA PERFORMANCE INDUSTRIES, INC. as listed above or visit our website at [www.kwausa.com](http://www.kwausa.com) to contact us. (3) Damages, deterioration, or malfunction resulting from: a) An accident, act of nature, abuse, misuse, neglect, opening of mechbox, or failure to follow instructions supplied with the product. b) Repair or attempted repair by anyone other than KWA PERFORMANCE INDUSTRIES, INC. (4) Products that are used outside the U.S.A. (5) Products damaged by damaged or incorrect batteries, (6) Products that have been used with low-grade or used ammo (BBs), (7) Products that have been used with non-approved propellants (ie. Propane, Red/Black Gas, 134a... etc.) (6) Products used in industrial, commercial, and/or professional applications. Products used as rental units are considered commercial units and carry no warranty with KWA.

### What KWA Will Pay For

If your KWA product is found to be defective by KWA Performance Industries, Inc. during the applicable warranty period (which begins from the date of original purchase), KWA Performance Industries, Inc. will repair, or at its option, replace with a new, used, or equivalent model, the defective product without charge for parts or labor. Proof of purchase must be present for the warranty to be honored.

## How To Obtain Warranty Service

If your product needs service, it may be taken or shipped to KWA Performance Industries, Inc. The following procedures apply whenever your unit must be transported for warranty service:

- You must go to the RMA Request link at [www.kwausa.com](http://www.kwausa.com) to obtain an RMA number. THE RMA NUMBER MUST BE CLEARLY MARKED ON THE OUTSIDE OF THE PACKAGE. PACKAGES WITHOUT AN RMA NUMBER CLEARLY MARKED WILL BE REFUSED AND RETURNED TO THE SENDER.
- You are responsible for transporting your unit or arranging for its transportation.
- If shipment of your unit is required; you must pay the initial shipping fee, but we will pay the return shipping charge if the repairs are covered by the warranty
- WHEN RETURNING YOUR UNIT FOR WARRANTY SERVICE, A COPY OF THE ORIGINAL SALES RECEIPT MUST BE ATTACHED.
- You must include the following: RMA number; your name, address, daytime telephone number; model and serial number (if applicable) of the product and a description of the problem.

## This Warranty is Only Valid in the United States

If your product does not require service, but you have questions regarding its operation, please contact our Customer Service Team at [www.kwausa.com](http://www.kwausa.com).

THIS WARRANTY IS EXPRESSLY MADE IN LIEU OF ALL OTHER WARRANTIES, EXPRESSED OR IMPLIED, INCLUDING WITHOUT LIMITATION, WARRANTIES OF MERCHANTABILITY AND FITNESS FOR A PARTICULAR PURPOSE.

OUR LIABILITY IS LIMITED TO THE REPAIR OR REPLACEMENT, AT OUR OPTION, OF ANY DEFECTIVE PRODUCT AND SHALL IN NO EVENT INCLUDE INCIDENTAL OR CONSEQUENTIAL COMMERCIAL OR PROPERTY DAMAGES OF ANY KIND. WE ARE NOT RESPONSIBLE FOR PRODUCTS LOST, STOLEN AND/OR DAMAGED DURING SHIPPING.

SINCE SOME STATES DO NOT ALLOW LIMITATIONS ON HOW LONG AN IMPLIED WARRANTY LASTS AND/OR DO NOT ALLOW THE EXCLUSION OF INCIDENTAL OR CONSEQUENTIAL DAMAGES, THE ABOVE LIMITATIONS AND EXCLUSIONS MAY NOT APPLY TO YOU.

This warranty gives you specific legal rights, but you may also have other rights which vary from state to state. This warranty may not be altered other than in writing signed by an officer of KWA Performance Industries, Inc.

SKU: 104-01406

**RONIN TACTICAL SERIES**

**VM4 T6 PDW - RIFLE SPECIFICATIONS**

## 0 - RIFLE SPECIFICATIONS

The next generation of variable FPS Ronin AEGs have arrived. KWA's upgraded VM4 AEG 2.5 gearbox are now drop-in trigger ready allowing users to employ their favorite MOSFETs or electronic triggers to maximize weapon performance. The Ronin T6 PDW is stacked with features derived from extensive user feedback; from the redesigned MLOK handguards, improved PDW stock, ambidextrous charging handle and KWA's brand new SOCOM-style muzzle brake, the T6 is once again ready to dominate the playing field.



## SPECIFICATIONS

LENGTH (RETRACTED):	21.75"	552.45 MM
LENGTH (EXTENDED):	26.5"	673.1 MM
HEIGHT:	10.5"	266.7 MM
OUTER BARREL LENGTH:	6.75"	171.45 MM
INNER BARREL LENGTH:	7.25"	184.15 MM
MAGAZINE CAPACITY:	120	120
WEIGHT:	5.7 LBS	2.59 KG
RATE OF FIRE:	18.3 0 RPS	18.3 RPS (ROUNDS PER SECOND)
VELOCITY:	~ 340 FPS MIN ~ 370 FPS MAX, ADJUSTABLE FPS	
POWER SOURCE:	NIMH OR LI-PO/LI-FE	

## 1 - THE BASICS

Prepare your gun for operation by removing the collapsible tanker/PDW style stock. Fully extend the butt stock assembly to the longest position and then depress the button on the underside of the stock housing. Once the butt stock is removed, you can then remove the battery cover plate by pushing down on the tab and pulling out.



With the battery cover plate removed, carefully locate the Tamiya connector and fuse housing and pull both components outside of the stock housing. Inspect the fuse by checking the window for any damage to the fuse. A damaged fuse will either look dirty or sooty or the fuse wiring may be incomplete or severed. In either case, you will need to replace the fuse promptly.

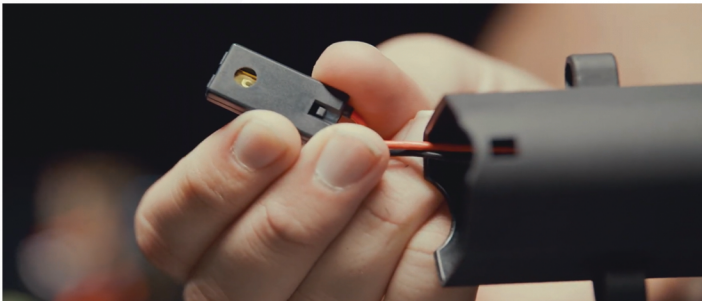

Connect your battery's Tamiya connector to the gun wiring. If the plugs do not smoothly click together, you may need to adjust the connector's orientation to ensure proper terminal connection. Forcing the plugs together can damage the internal terminals and cause damage to wiring preventing the gun from securing to the power source. Insert the battery into the stock housing and neatly tuck in the remaining wiring. Try to avoid bending the wiring excessively as this can greatly affect performance and may cause damage to the wiring. Replace the battery cover plate and reinstall the butt stock assembly.



## 2 - LOADING BB'S

To load BB's, locate the BB's loading port found on the top front section of the magazine. BB's can be loaded either manually by hand or by using a specifically designed BB loader. Continue to load BB's into the loading port until you experience some resistance in loading more. Once no more BB's can be pushed down, your magazine is full. Excessively forcing more BB's in will only cause damage to your magazine or your BB loader.



With a full magazine, you can now insert your magazine into the magazine well of your rifle.



Prepare to fire your gun by removing the gun from the "safe" position to the semi or auto position. Ensure you are aiming at a safe target and press the trigger to fire a BB. In semi-automatic mode, a BB will fire with every trigger pull. On full automatic, BB's will fire continuously until the shooters finger releases the trigger. When not firing the rifle, always place the gun on safe. Remove the magazine by pressing the magazine catch and ensure there is not a BB loaded

### 3 - ADJUSTING FPS AND SIGHTS - A

The T6 is an AEG 2.5, which means it features KWA's Variable Performance System (VPS). This unit allows for the quick and easy adjustment of your Tekken's FPS. Each full rotation of the included VPS hex tool will adjust your FPS by approximately 2.5 FPS. The maximum and minimum FPS rating will depend on the spring that is installed in the T6's mechbox. We've also included the steps to use the AEG 2.5's quick-change spring system below.

To adjust the FPS in your T6:

1. Extend retractable butt plate to rearmost position, or remove entirely by pressing metal lever under stock while pulling butt plate out.
2. Press tab on top of polymer battery retention plate and pull the plate off.
3. Using a Phillips screwdriver, remove the stock retainer and screw, parts 461, 240, and 508 in the T6 diagram (located on the last pages of this manual).
4. Insert your VPS tool into the exposed hole in the VPS. To increase the FPS, rotate the VPS tool clockwise, and to lower the FPS, rotate the tool counter-clockwise.\* Do not force the VPS to turn after lowering the FPS to the minimum, or the internal adjustment screw may come loose. Reinstall the stock retainer, washer, and screw to complete your FPS adjustment.

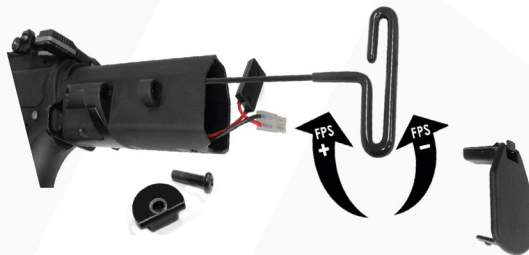

\*If you want to change the FPS range in your T6 with its quick-change spring system, you can do so during this step! You'll need to remove your VPS unit, which you can easily do (after removing the retainer and screw) by pressing the unit inward and rotating it counter-clockwise by 30 degrees. The SPRING LOADED UNIT WILL POP OUT, AND EYE PROTECTION IS RECOMMENDED DURING THIS PROCESS! Simply replace the main spring and reinsert the VPS by inserting it into its housing and rotating it clockwise until it locks into place. After that, reinstall the stock retainer, washer and screw to complete the spring swap. The new FPS range is determined by the M rating of the newly installed spring, with a standard variance of 40-50 FPS.



### 3 - ADJUSTING FPS AND SIGHTS - B

#### PTS Enhanced Polymer Back-Up Iron Sights

The Ronin Tactical Series AEGs use the PTS Enhanced Polymer Back-Up Iron Sights, which are made from ultra-durable DuPont Zytel High Performance Reinforced Polymer. The sights feature a low-profile, snag-free design that allows for sight adjustment without the use of any tools.

#### Front Sight:

To adjust the elevation setting on the front sight, simply rotate the polymer wheel to either raise or lower the sight post. Do not rotate the wheel too far, or the post may fall out.

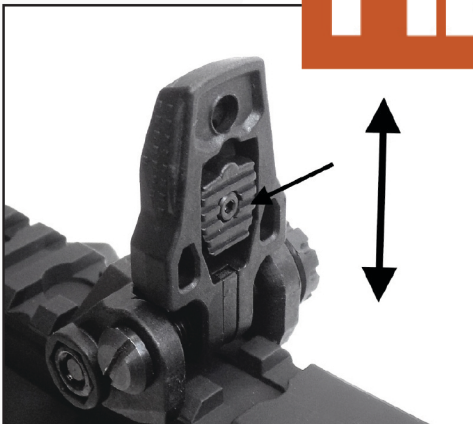

#### Rear Sight:











The rear sight features both large and small apertures and can be adjusted by shifting the center plate up or down. Windage is also adjustable by rotating the knob located on the right side of the sight.

## 4 - HOP UP ADJUSTMENT

To adjust your hop up, first expose your hop up assembly by pulling the charging handle to the rear and locking it back by depressing the bolt catch. Now test fire your gun in a safe direction and observe your flight path.



Once your hop up assembly is exposed and accessible, you can increase hop by rotating the hop up wheel up and reduce hop by rotating the wheel down.

BB TRAJECTORY PATTERN		ADJUSTMENTS
	BB DROPS FREELY	 TURN KNOB UPWARD
	BB TRAVELS AT SHORT TRAJECTORY PATH	 TURN KNOB SLIGHTLY UPWARD
	BB TRAVELS DISTANCE AT FLAT TRAJECTORY PATH	 NO ADJUSTMENTS NECESSARY
	BB TRAVELS FLAT IN SHORT DISTANCE, THEN GOES UP IN CURVE AND DROPS FREELY	 TURN KNOB SLIGHTLY DOWNWARD
	BB TRAVELS AT UNSTABLE SPEED AND IRREGULAR PATH	 TURN KNOB DOWNWARD

Once you have an acceptable shooting trajectory, you can stop adjusting and hit the bolt catch to release your mock bolt plate.

## 5 - DISASSEMBLING THE GUN

To disassemble your AEG for maintenance, remove the magazine and battery before continuing. Next, push the receiver front take down pin ensuring it is not blocking the upper receiver. Close the dust cover, then pull the charging handle to the rear while applying forward pressure to slide the upper receiver off. While removing the upper receiver, pay careful attention to the mock bolt plate ensuring it does wiggle free.



Once the upper is free from the lower receiver, slowly remove the inner barrel, inner barrel spring, and hop up unit. To clean your inner barrel, turn the hop up all the way up and use a cleaning rod with a barrel cleaning patch to clean your bore. After several passes with the cleaning rod and cloth/patch, the inner barrel should be free of any residue or dirt. Repeat this process until completely clean.

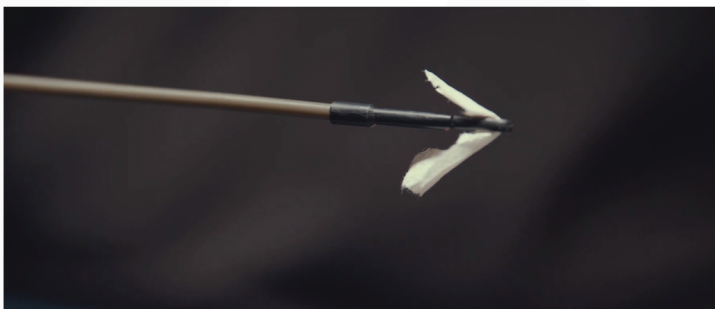

Reinstall the inner barrel back into the upper receiver and outer barrel. When sliding the upper receiver back onto the lower receiver, pay close attention to the mock bolt plate as it may catch the upper receiver and bend out of place. The bolt catch may also prevent the upper from sliding onto the lower easily, press the bottom portion of the bolt catch out of the way to ensure the upper slides on properly.

## 6 - TROUBLESHOOTING

If your gun is not shooting, first verify that the gun is off safe and in the semi or automatic position. Next, visually inspect your wiring on both your battery and AEG as frayed, kinked, exposed wiring can easily cause your AEG to malfunction. Inspect the Tamiya connectors and verify that both terminals are completely seated to your battery. Further inspection of the wiring connecting inside of the buffer tube and leading into the gearbox may also be required.

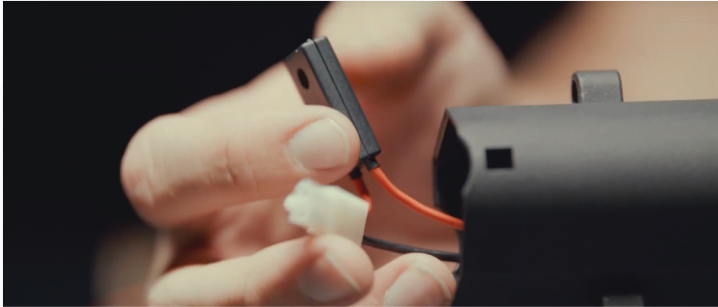

If the issue persists, please contact KWA Customer Service for further instructions and RMA repair.



If your motor or battery is excessively hot after normal usage, you may have a pinched wire and it is recommended to contact KWA Customer Service for assistance.

Please note, our guns do have a break-in period of 1,000 rounds. You may experience less than optimal hop-up performance prior to reaching the 1,000 round break-in.

8 - PARTS DIAGRAM PAGE 2

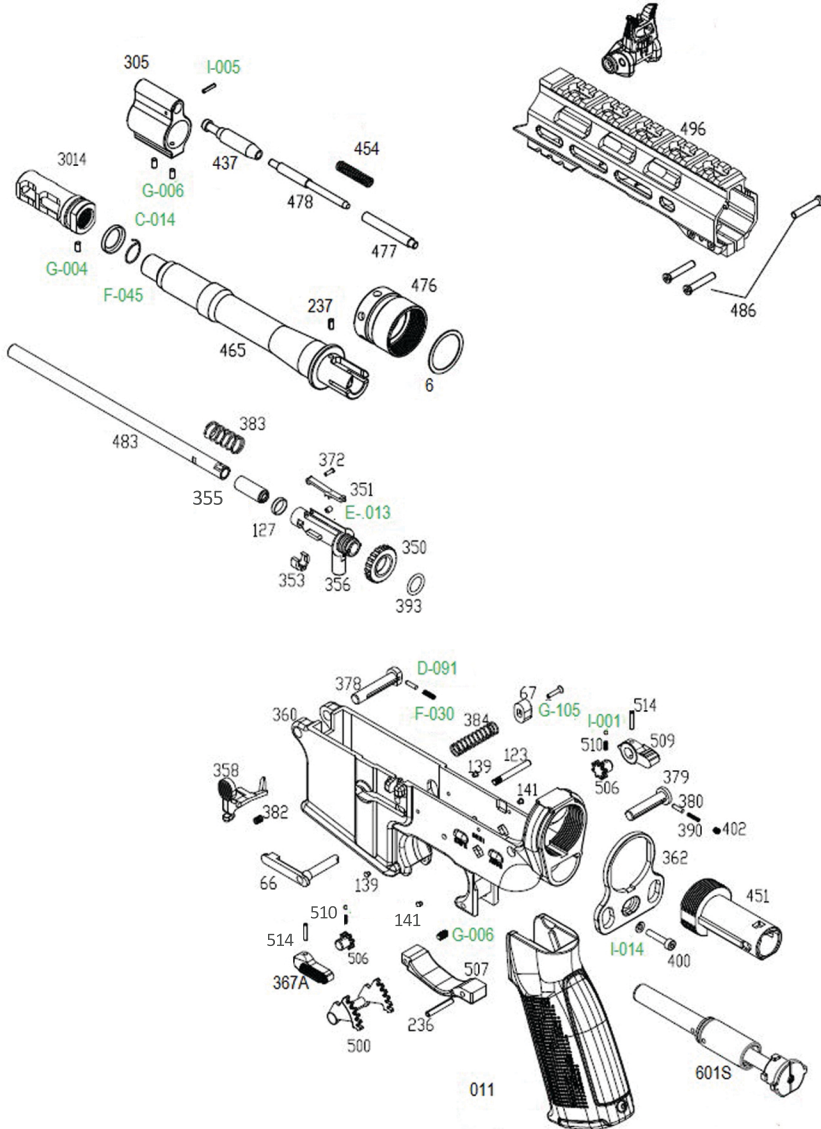

7 - PARTS DIAGRAM PAGE 1

